



Features

- Reliable, Low-Cost HBT Design
- 12.0dB Gain, +13.8dBm P1dB@2GHz
- High P1dB of +14.3dBm@6.0GHz and +11.2dBm@14.0GHz
- Single Power Supply Operation
- 50Ω I/O Matched for High Freq. Use

Applications

- Narrow and Broadband Commercial and Military Radio Designs
- Linear and Saturated Amplifiers
- Gain Stage or Driver Amplifiers for MWRadio/Optical Designs (PTP/PMP/LMDS/UNII/VSAT/WLAN/Cellular/DWDM)

Package Drawing

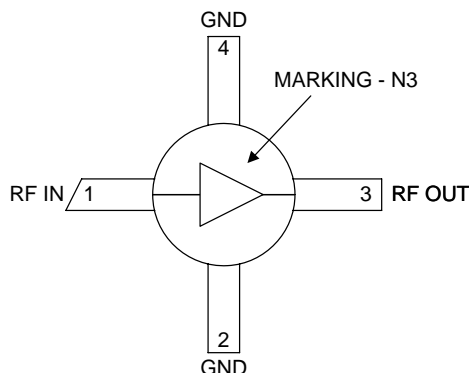
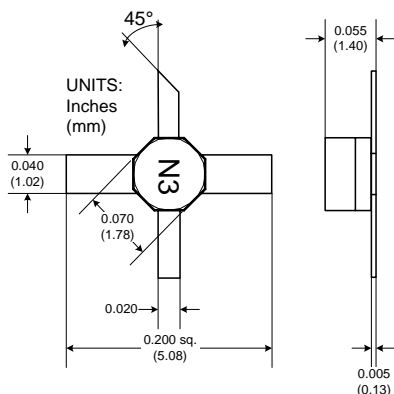

Functional Block Diagram

Product Description

The NBB-300 cascadable broadband InGaP/GaAs MMIC amplifier is a low-cost, high-performance solution for general purpose RF and microwave amplification needs. This 50Ω gain block is based on a reliable HBT proprietary MMIC design, providing unsurpassed performance for small-signal applications. Designed with an external bias resistor, the NBB-300 provides flexibility and stability. The NBB-300 is packaged in a low-cost, surface-mount ceramic package, providing ease of assembly for high-volume tape-and-reel requirements. It is available in either packaged or chip (NBB-300-D) form, where its gold metallization is ideal for hybrid circuit designs.

Ordering Information

NBB-300	Cascadable Broadband GaAs MMIC Amplifier DC to 12GHz
NBB-300-T1	Tape & Reel, 1000 Pieces
NBB-300-D	NBB-300 Chip Form (100 pieces minimum order)
NBB-300-E	Fully Assembled Evaluation Board
NBB-X-K1	Extended Frequency InGaP Amp Designer's Tool Kit

Optimum Technology Matching® Applied

- | | | | |
|---|--------------------------------------|-------------------------------------|-----------------------------------|
| <input type="checkbox"/> GaAs HBT | <input type="checkbox"/> SiGe BiCMOS | <input type="checkbox"/> GaAs pHEMT | <input type="checkbox"/> GaN HEMT |
| <input type="checkbox"/> GaAs MESFET | <input type="checkbox"/> Si BiCMOS | <input type="checkbox"/> Si CMOS | |
| <input checked="" type="checkbox"/> InGaP HBT | <input type="checkbox"/> SiGe HBT | <input type="checkbox"/> Si BJT | |

RF MICRO DEVICES®, RFMD®, Optimum Technology Matching®, Enabling Wireless Connectivity™, PowerStar®, POLARIS™ TOTAL RADIO™ and UltimateBlue™ are trademarks of RFMD, LLC. BLUETOOTH is a trademark owned by Bluetooth SIG, Inc., U.S.A. and licensed for use by RFMD. All other trade names, trademarks and registered trademarks are the property of their respective owners. ©2006, RF Micro Devices, Inc.

Absolute Maximum Ratings

Parameter	Rating	Unit
RF Input Power	+20	dBm
Power Dissipation	300	mW
Device Current	70	mA
Channel Temperature	200	°C
Operating Temperature	-45 to +85	°C
Storage Temperature	-65 to +150	°C

Exceeding any one or a combination of these limits may cause permanent damage.



Caution! ESD sensitive device.

The information in this publication is believed to be accurate and reliable. However, no responsibility is assumed by RF Micro Devices, Inc. ("RFMD") for its use, nor for any infringement of patents, or other rights of third parties, resulting from its use. No license is granted by implication or otherwise under any patent or patent rights of RFMD. RFMD reserves the right to change component circuitry, recommended application circuitry and specifications at any time without prior notice.

RoHS status based on EUDirective2002/95/EC (at time of this document revision).

Parameter	Specification			Unit	Condition
	Min.	Typ.	Max.		
Overall					$V_D = +3.9V, I_{CC} = 50mA, Z_0 = 50\Omega, T_A = +25^\circ C$
Small Signal Power Gain, S21	12.0	13.0		dB	f=0.1GHz to 1.0GHz
	11.0	13.0		dB	f=1.0GHz to 4.0GHz
		11.0		dB	f=4.0GHz to 6.0GHz
	9.0	9.5		dB	f=6.0GHz to 12.0GHz
		8.0		dB	f=12.0GHz to 14.0GHz
Gain Flatness, GF		±0.6		dB	f=0.1GHz to 4.0GHz
Input and Output VSWR		2.4:1			f=0.1GHz to 4.0GHz
		2.0:1			f=4.0GHz to 6.0GHz
		2.5:1			f=6.0GHz to 12.0GHz
Bandwidth, BW		12.5		GHz	BW3 (3dB)
Output Power @ -1dB Compression, P1dB		13.0		dBm	f=2.0GHz
		13.8		dBm	f=6.0GHz
		12.0		dBm	f=14.0GHz
Noise Figure, NF		5.1		dB	f=3.0GHz
Third Order Intercept, IP3		+27.1		dBm	f=2.0GHz
Reverse Isolation, S12		-15		dB	f=0.1GHz to 12.0GHz
Device Voltage, V_D	3.6	3.9	4.2	V	
Gain Temperature Coefficient, $\delta G_T / \delta T$		-0.0015		dB/°C	
MTTF versus Temperature @ $I_{CC} = 50mA$					
Case Temperature		85		°C	
Junction Temperature		138		°C	
MTTF		>1,000,000		hours	
Thermal Resistance					
θ_{JC}		272		°C/W	$\frac{J_T - T_{CASE}}{V_D \cdot I_{CC}} = \theta_{JC} (^\circ C/Watt)$

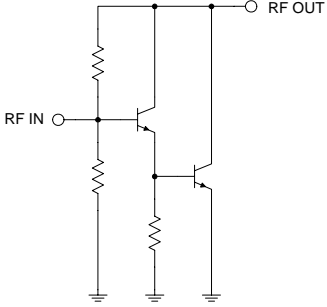
Pin	Function	Description	Interface Schematic
1	RF IN	RF input pin. This pin is NOT internally DC blocked. A DC blocking capacitor, suitable for the frequency of operation, should be used in most applications. DC coupling of the input is not allowed, because this will override the internal feedback loop and cause temperature instability.	
2	GND	Ground connection. For best performance, keep traces physically short and connect immediately to ground plane.	
3	RF OUT	RF output and bias pin. Biasing is accomplished with an external series resistor and choke inductor to V_{CC} . The resistor is selected to set the DC current into this pin to a desired level. The resistor value is determined by the following equation: $R = \frac{(V_{CC} - V_{DEVICE})}{I_{CC}}$ Care should also be taken in the resistor selection to ensure that the current into the part never exceeds maximum datasheet operating current over the planned operating temperature. This means that a resistor between the supply and this pin is always required, even if a supply near 5.0V is available, to provide DC feedback to prevent thermal runaway. Because DC is present on this pin, a DC blocking capacitor, suitable for the frequency of operation, should be used in most applications. The supply side of the bias network should also be well bypassed.	
4	GND	Same as pin 2.	

Typical Bias Configuration

Application notes related to biasing circuit, device footprint, and thermal considerations are available on request.

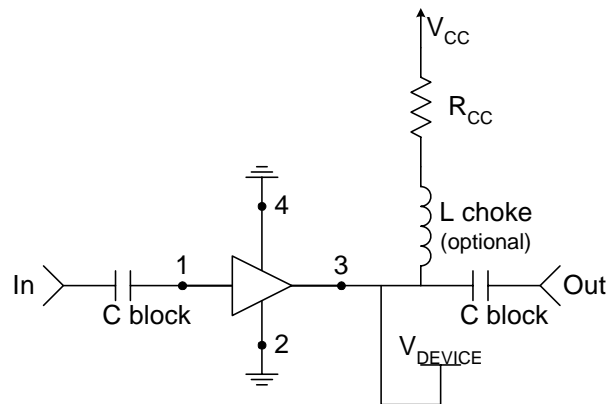

Recommended Bias Resistor Values						
Supply Voltage, V_{CC} (V)	5	8	10	12	15	20
Bias Resistor, R_{CC} (Ω)	22	81	122	162	222	322

Chip Outline Drawing - NBB-300-D

Chip Dimensions: 0.017" x 0.017" x 0.004"

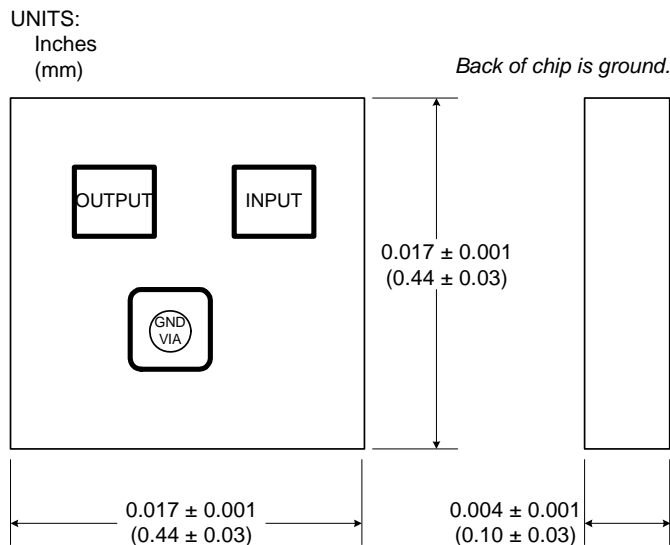

Sales Criteria - Unpackaged Die

Die Sales Information

- All segmented die are sold 100% DC-tested. Testing parameters for wafer-level sales of die material shall be negotiated on a case-by-case basis.
- Segmented die are selected for customer shipment in accordance with RFMD Document #6000152 - Die Product Final Visual Inspection Criteria¹.
- Segmented die has a minimum sales volume of 100 pieces per order. A maximum of 400 die per carrier is allowable.

Die Packaging

- All die are packaged in GelPak ESD protective containers with the following specification: O.D.=2" X2", Capacity=400 Die (20X20 segments), Retention Level=High(X0).
- GelPak ESD protective containers are placed in a static shield bag. RFMD recommends that once the bag is opened the GelPak/s should be stored in a controlled nitrogen environment. Do not press on the cover of a closed GelPak, handle by the edges only. Do not vacuum seal bags containing GelPak containers.
- Precaution must be taken to minimize vibration of packaging during handling, as die can shift during transit².

Package Storage

- Unit packages should be kept in a dry nitrogen environment for optimal assembly, performance, and reliability.
- Precaution must be taken to minimize vibration of packaging during handling, as die can shift during transit².

Die Handling

- Proper ESD precautions must be taken when handling die material.
- Die should be handled using vacuum pick-up equipment, or handled along the long side with a sharp pair of tweezers. Do not touch die with any part of the body.
- When using automated pick-up and placement equipment, ensure that force impact is set correctly. Excessive force may damage GaAs devices.

Die Attach

- The die attach process mechanically attaches the die to the circuit substrate. In addition, the utilization of proper die attach processes electrically connect the ground to the trace on which the chip is mounted. It also establishes the thermal path by which heat can leave the chip.
- Die should be mounted to a clean, flat surface. Epoxy or eutectic die attach are both acceptable attachment methods. Top and bottom metallization are gold. Conductive silver-filled epoxies are recommended. This procedure involves the use of epoxy to form a joint between the backside gold of the chip and the metallized area of the substrate.
- All connections should be made on the topside of the die. It is essential to performance that the backside be well grounded and that the length of topside interconnects be minimized.
- Some die utilize vias for effective grounding. Care must be exercised when mounting die to preclude excess run-out on the topside.

Die Wire Bonding

- Electrical connections to the chip are made through wire bonds. Either wedge or ball bonding methods are acceptable practices for wire bonding.
- All bond wires should be made as short as possible.

Notes

¹RFMD Document #6000152 - Die Product Final Visual Inspection Criteria. This document provides guidance for die inspection personnel to determine final visual acceptance of die product prior to shipping to customers.

²RFMD takes precautions to ensure that die product is shipped in accordance with quality standards established to minimize material shift. However, due to the physical size of die-level product, RFMD does not guarantee that material will not shift during transit, especially under extreme handling circumstances. Product replacement due to material shift will be at the discretion of RFMD.

Extended Frequency InGaP Amplifier Designer's Tool Kit NBB-X-K1

This tool kit was created to assist in the design-in of the RFMD NBB- and NLB-series InGaP HBT gain block amplifiers. Each tool kit contains the following.

- 5 each NBB-300, NBB-310 and NBB-400 Ceramic Micro-X Amplifiers
- 5 each NLB-300, NLB-310 and NLB-400 Plastic Micro-X Amplifiers
- 2 Broadband Evaluation Boards and High Frequency SMA Connectors
- Broadband Bias Instructions and Specification Summary Index for ease of operation

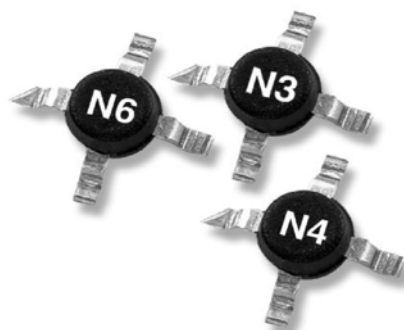
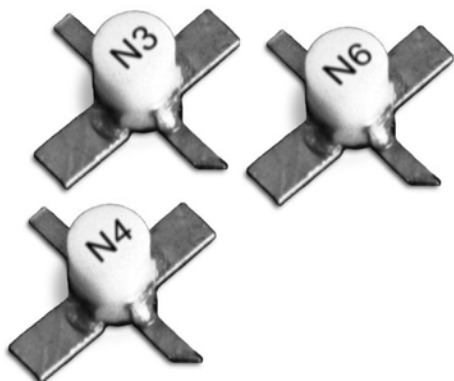

Tape and Reel Dimensions

All Dimensions in Millimeters

Carrier tape basic dimensions are based on EIA 481. The pocket is designed to hold the part for shipping and loading onto SMT manufacturing equipment, while protecting the body and the solder terminals from damaging stresses. The individual pocket design can vary from vendor to vendor, but width and pitch will be consistent.

Carrier tape is wound or placed onto a shipping reel 178 mm (7 inches) in diameter. The center hub design is large enough to ensure the radius formed by the carrier tape around it does not put unnecessary stress on the parts.

Prior to shipping, moisture sensitive parts (MSL Level 2a-5a) are baked and placed into the pockets of the carrier tape. A cover tape is sealed over the top of the entire length of the carrier tape. The reel is sealed in a moisture barrier ESD bag with the appropriate units of desiccant and a humidity indicator card, which is placed in a cardboard shipping box. It is important to note that unused moisture sensitive parts need to be resealed in the moisture barrier bag. If the reels exceed the exposure limit and need to be rebaked, most carrier tape and shipping reels are not rated as bakeable at 125 °C. If baking is required, devices may be baked according to section 4, table 4-1, column 8 of Joint Industry Standard IPC/JEDEC J-STD-033.

Table 1 provides useful information for carrier tape and reels used for shipping the devices described in this document.

Table 1. Tape and Reel

RFMD Part Number	Reel Diameter Inch (mm)	Hub Diameter Inch (mm)	Width (mm)	Pocket Pitch (mm)	Feed	Units per Reel
NBB-300	7 (178)	2.4 (61)	12	8	Single	1000

Notes:

- All dimensions are in millimeters (mm).
- Unless otherwise specified, all dimension tolerances per EIA-481.
- 10 sprocket hole pitch cumulative tolerance ± 0.02 .

$A_o = 5.8 \pm 1$
 $B_o = 6.1 \pm 1$
 $F = 5.50 \pm 0.05$
 $K_o = 2.0 \pm 1$
 $P = 8.0 \pm 1$
 $W = 12.0 \pm 3$

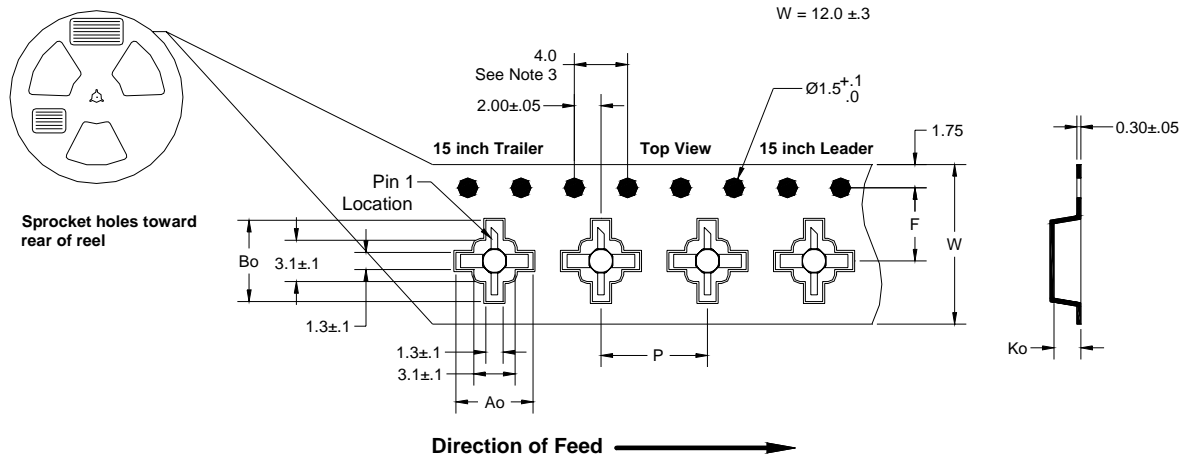
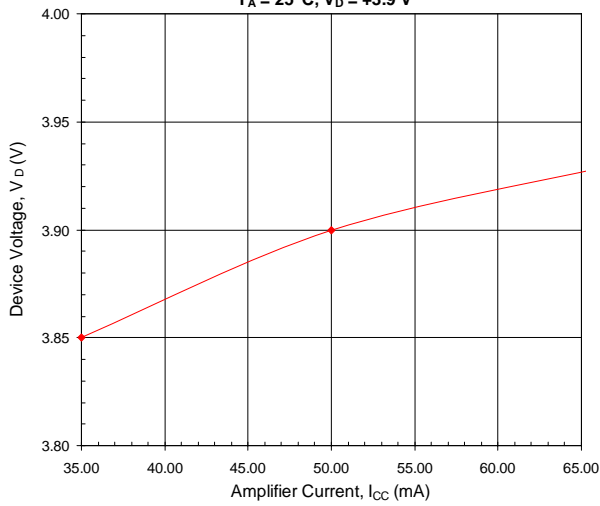

Figure 1. Carrier Tape Drawing with Part Orientation

Device Voltage versus Amplifier Current

$T_A = 25^\circ\text{C}$, $V_D = +3.9\text{ V}$



P1dB versus Frequency at 25°C

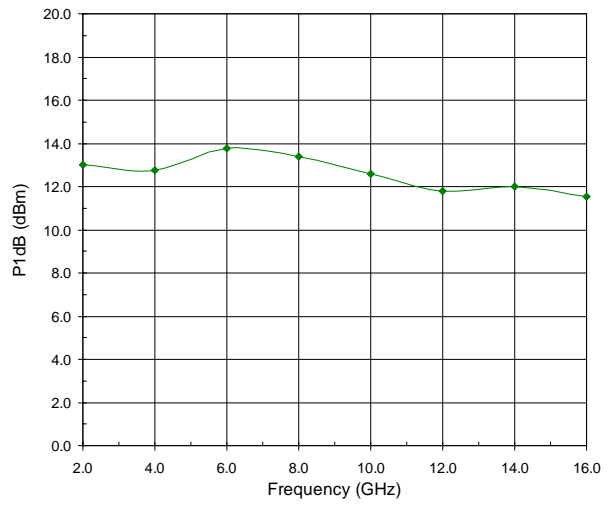

P_{OUT}/Gain versus P_{IN} at 6 GHz

$T_A = 25^\circ\text{C}$, $V_D = +3.9\text{ V}$

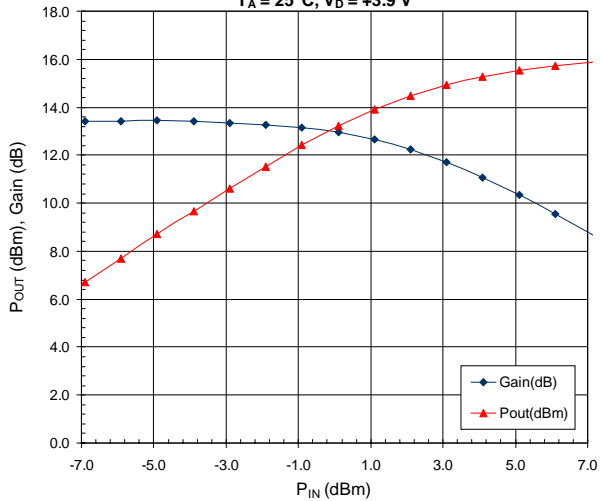

P_{OUT}/Gain versus P_{IN} at 14 GHz

$T_A = 25^\circ\text{C}$, $V_D = +3.9\text{ V}$

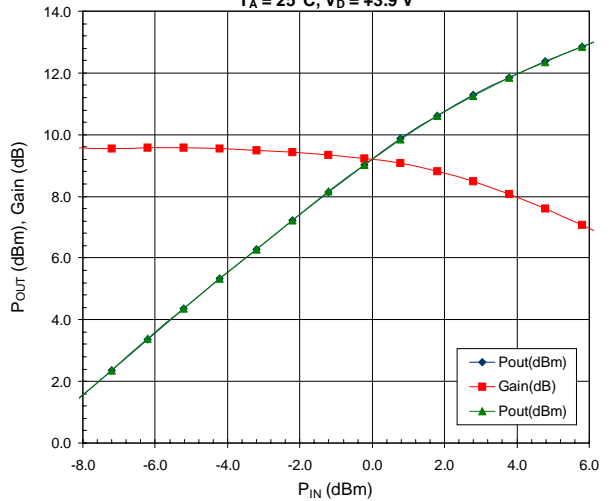

Third Order Intercept versus Frequency

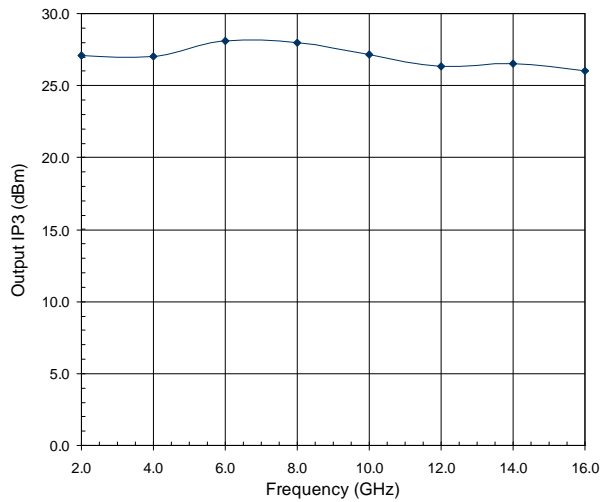

Note: The s-parameter gain results shown below include device performance as well as evaluation board and connector loss variations. The insertion losses of the evaluation board and connectors are as follows:

- 1GHz to 4GHz=-0.06dB
- 5GHz to 9GHz=-0.22dB
- 10GHz to 14GHz=-0.50dB
- 15GHz to 20GHz=-1.08dB

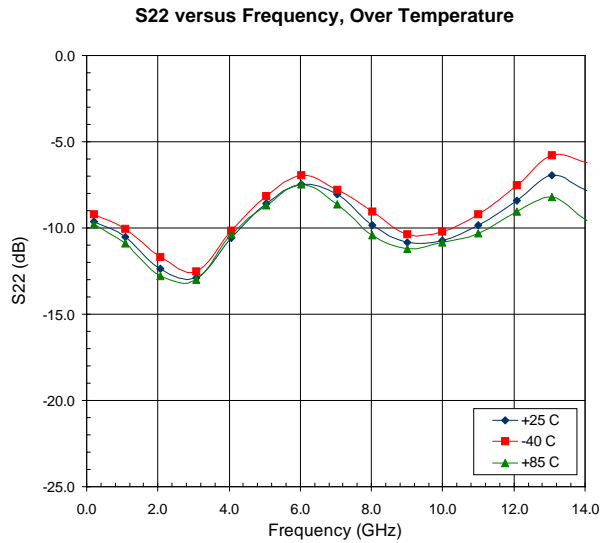
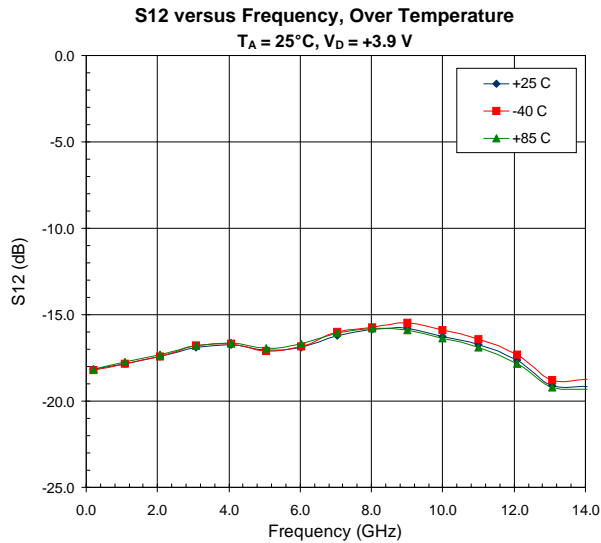
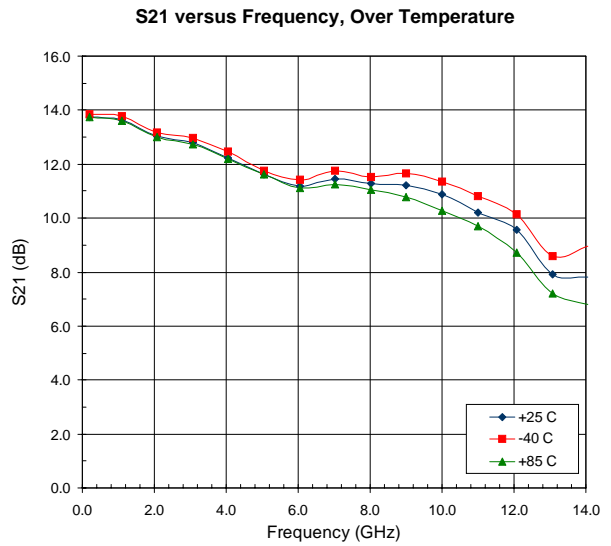
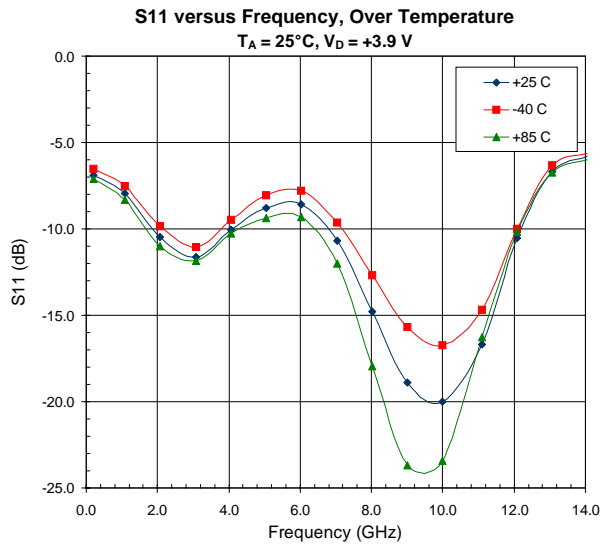

RoHS* Banned Material Content

RoHS Compliant: Yes
 Package total weight in grams (g): 0.019
 Compliance Date Code: 0438
 Bill of Materials Revision: -
 Pb Free Category: e3

Bill of Materials	Parts Per Million (PPM)					
	Pb	Cd	Hg	Cr VI	PBB	PBDE
Die	0	0	0	0	0	0
Molding Compound	0	0	0	0	0	0
Lead Frame	0	0	0	0	0	0
Die Attach Epoxy	0	0	0	0	0	0
Wire	0	0	0	0	0	0
Solder Plating	0	0	0	0	0	0

This RoHS banned material content declaration was prepared solely on information, including analytical data, provided to RFMD by its suppliers, and applies to the Bill of Materials (BOM) revision noted

* DIRECTIVE 2002/95/EC OF THE EUROPEAN PARLIAMENT AND OF THE COUNCIL of 27 January 2003 on the restriction of the use of certain hazardous substances in electrical and electronic equipment

Ordering Information

NBB-300-T1 Tape & Reel, 1000 Pieces
 NBB-300-D NBB-300 Chip Form (100 pieces minimum order)
 NBB-300-E Fully Assembled Evaluation Board
 NBB-X-K1 Extended Frequency InGaP Amp Designer's Tool Kit